

**FECHADURAS ALAVANCA**  
CERRADURAS PALANCA  
HANDLE ACTION LOCKS  
SERRURES RELEVAGE





# ÍNDICE

FECHADURA DE ALAVANCA  
CERRADURA DE PALANCA  
HANDLE ACTION LOCK  
SERRURES RELEVAGE

FECHADURAS DE ALAVANCA 3 PONTOS CERRADURAS DE PALANCA 3 PUNTOS 3 POINTS HANDLE ACTION LOCK SERRURES RELEVAGE 3 POINTS	04
FECHADURAS DE ALAVANCA CHAPAS TESTA CERRADURAS DE PALANCA CERRADEROS HANDLE ACTION LOCK STRIKER PLATES SERRURES RELEVAGE GÂCHES	05
FECHADURA DE ALAVANCA 3 PONTOS COM GANCHO + ROLETOS CERRADURA DE PALANCA 3 PUNTOS CON PALANCA + ROLETOS 3 POINTS HANDLE ACTION LOCK WITH LEVER + ROLLER SERRURES RELEVAGE 3 POINTS AVEC RELEVAGE +ROULEAUX	06
FECHADURA DE ALAVANCA 3 PONTOS COM ROLETOS CERRADURA DE PALANCA 3 PUNTOS CON ROLETOS 3 POINTS HANDLE ACTION LOCK WITH ROLLER SERRURES RELEVAGE 3 POINTS AVEC ROULEAUX	07
FECHADURA DE ALAVANCA 3 PONTOS COM COGUMELOS CERRADURA DE PALANCA 3 PUNTOS CON BULONES 3 POINTS HANDLE ACTION LOCK WITH MUSHROOMS SERRURES RELEVAGE 3 POINTS AVEC CHAMPIGNONS	07
FECHADURA DE ALAVANCA 1 PONTO CERRADURA DE PALANCA 1 PUNTOS 1 POINT HANDLE ACTION LOCK SERRURE RELEVAGE 1 POINT	10
FECHADURA DE ALAVANCA MULTIPONTO CERRADURA DE PALANCA MULTIPUNTO MULTIPOINT HANDLE ACTION LOCK SERRURE RELEVAGE MULTIPOINT	11
INSTRUÇÕES INSTRUCCIONES INSTRUCTIONS INSTRUCTIONS	12

# SUMÁRIO ICONES

ICONES  
ICONOS  
ICONS  
ICÔNES

## EMBALAGENS - ENVASES - PACKAGING - EMBALLAGES

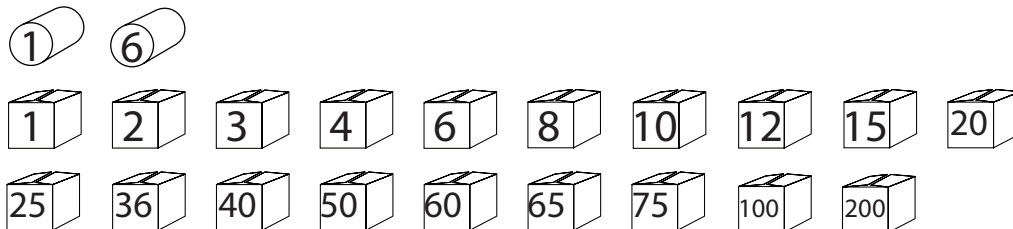

## MATERIAIS - MATERIALES - MATERIALS - MATÉRIELS



## ACABAMENTOS - ACABADOS - FINISHINGS - FINITIONS





## CORES - COLORES - COLOURS - COLEURS





COR POR ENCOMENDA - COLOR POR ENCARGO - COLOR BY REQUEST - COLEUR PAR COMMANDE

 Refs. 6200 mate (verde 61) - 6192 (verde 62) - 6005 - 6005 (mate) - 6009

 Refs. 1013 - 1015 - 1015(mate)

 Refs. 8014 - 8017 - 8146 - 8146 (mate)

 Refs. 7011 - 7012 - 7035 (mate) - 7040 - 7042 - 7048 - 9002 - 9006

 Refs. 9001 - 9003 - 9010 - 9110 (mate)

 Refs. 3003 - 3005

 Refs. 5010 - 5013

 Refs. 1011



## MEDIDAS - MEDIDAS - SIZES - MESURES



- Distância do meio do cilindro à frente da fechadura.
- Distancia desde el medio del cilindro al frente de la cerradura.
- Distance from the middle of the cylinder to the lock front plate.
- Distance à du milieu du cylindre jusqu'au têtère.



- Distância do meio do quadrado até o centro do cilindro.
- Distancia desde el medio del cuadradillo hasta el centro del cilindro.
- Distance from the middle of the square to the middle of cylinder.
- Distance du milieu du carré jusqu'au milieu du cylindre.



- Testa lisa / testa U
- Frente plano / frente U
- Flat shape / U shape
- Têtère plate / têtère u

## REGULAÇÃO - REGULACIÓN - REGULATION - RÉGLAGE



## CONCEITOS - CONCEPTOS - CONCEPTS - CONCEPTS



Instalação rápida da dobradiça no perfil - Instalación rápida de la bisagra en el canal  
 Easy installation in the profiles - Instalation facile de la paumelle dans le profil



Caixas estreitas para perfis de corte térmico - Cajas estrechas para perfiles de corte térmico  
 Narrow boxes for thermal break profiles - Boîtes étroites pour profilés à rupture thermique



Flexibilidade/ facilidade na permuta de trinco para rolete ou viceversa  
 Flexibilidad / facilidad en la permuta del picaporte para rodillo y viceversa  
 Flexibility / facility on the the swap latch to the roller and vice versa  
 Flexibilité / facilité au chagement entre demi-tour et rouleau

As imagens contidas neste catálogo, destinam-se à promoção dos produtos e fruto do seu constante desenvolvimento, podem não reflectir a forma como num dado momento, um produto é fornecido ou embalado, pelo que por si não constituem uma obrigação legal. Antes de cada encomenda é sempre necessário confirmar o seu estado actual.

Las imágenes mostradas en este catálogo se destinan a la promoción de sus productos y fruto de su constante desarrollo pueden no reflejar la forma en como en un momento dado, el producto puede ser distribuido o embalado, de modo que por si, no constituyen una obligación legal. Antes de cada pedido será necesario confirmar su estado actual.

The images in this catalogue are intended to promote the product and by its constant development, may not reflect the way a product is being delivered or packaged, so by themselves they do not constitute a legal obligation. Before each order it is always necessary to confirm its current status.

Les images de ce catalogue se destinent à la promotion des produits et elles ne constituent pas une obligation contractuelle de la façon dont les produits sont finalement fabriqués, emballés ou vendus. Avant une commande ils faut toujours vérifier sont stade actuelle.

## FECHADURAS ALAVANCA

# FECHADURA DE ALAVANCA 3 PONTOS

CERRADURA DE PALANCA 3 PUNTOS  
3 POINTS HANDLE ACTION LOCK  
SERRURES RELEVAGE 3 POINTS



Fechadura superior com língua em forma de gancho em inox.

Cerradura superior con palanca en forma de gancho em inox.

Top lock with inox hook bolt.

Serrure supérieure à levier en forme de crochet inox.

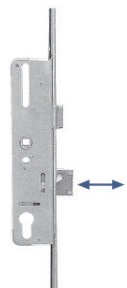

Fechadura central com trinco reversível e rolete e língua deslizante em zamak.

Cerradura central con picaporte reversible y palanca deslizante en zamak.

Center lock with reversible latch and roller and advancing bolt.

Verrouillage central avec le verrou réversible et levier coulissant en zamak.



Fechadura inferior com língua em forma de gancho em inox.

Cerradura inferior con palanca en forma de gancho em inox.

Down lock with stainless steel hook bolt.

Serrure inférieure à levier en forme de crochet inox.

■ Fechadura superior com língua em forma de gancho em inox.

Fechadura central com trinco reversível ou rolete e língua deslizante.

Fechadura inferior com língua em forma de gancho inox. Com uma distância entre o cilindro e o puxador de 85mm/92mm.

Com uma altura de 1600mm/ 1850mm/ 2100mm.

■ Cerradura superior con palanca en forma de gancho em inox.

Cerradura central com picaporte reversible o rodillo y palanca deslizante.

Cerradura inferior con palanca en forma de gancho inox. Distancia entre el cilindro y la manilla de 85mm/92mm. Con una altura de 1600mm/ 1850mm.

■ Top lock with inox hook bolt.

Center lock with reversible latch or roller and advancing bolt.

Down lock inox hook bolt.

Center distance from the center of the spindle to the center of the cylinder 85mm/92mm. Lock might 1600mm/ 1850mm.

■ Levier de verrouillage supérieure accroché inoxydable.

Verrouillage central avec le verrou réversible et le levier coulissant.

Levier de verrouillage fond en forme de crochet en inox. Distance entre le cylindre et la poignée 85 mm / 92 mm. Hauteur de 1600mm / 1850mm.



# FECHADURAS ALAVANCA CHAPAS TESTA

CERRADURA DE PALANCA CERRADEROS  
HANDLE ACTION LOCK STRIKER PLATES  
SERRURES RELEVAGE GÂCHES

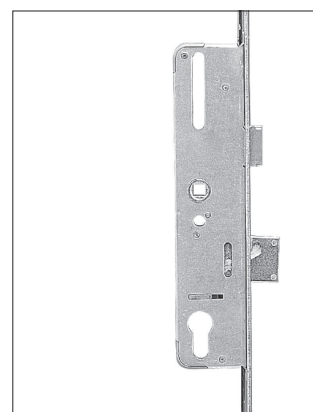
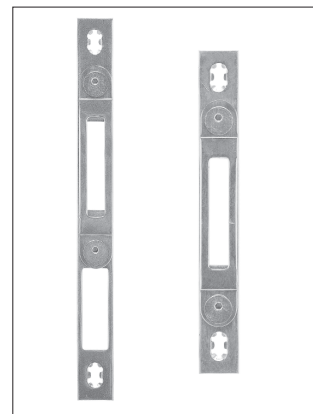
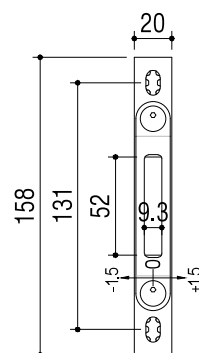
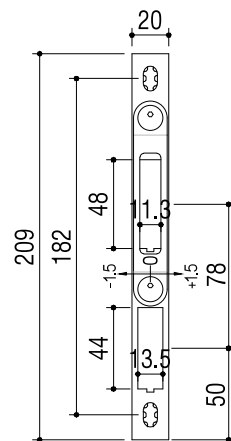
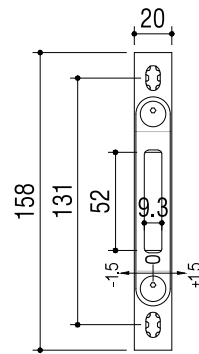

- Fechadura em posição de segurança    ■ Fechadura em posição livre
- Cerradura en posición de seguridad    Cerradura en posición libre
- Lock in safety position    Lock in rest position
- Position de sécurité de la verrouillage.    Serrure en position libre.

## FECHADURAS ALAVANCA

# FECHADURA DE ALAVANCA 3 PONTOS

CERRADURA DE PALANCA 3 PUNTOS  
3 POINTS HANDLE ACTION LOCK  
SERRURES RELEVAGE 3 POINTS

### GANCHO/PALANCA/LEVER/RELEVAGE

REFS.	TESTA FRENTE FRONT GÂCHE	FECHADURA CERRADURA LOCK SERRURE
7290	16	92mm
7291	22	92mm
7292	24	92mm
7780	16	85mm
7781	22	85mm
7782	24	85mm



### GANCHO+ROLETOS/PALANCA+ROLETOS/ LEVER+ROLLER/RELEVAGE+ ROULEAUX

REFS.	TESTA FRENTE FRONT GÂCHE	FECHADURA CERRADURA LOCK SERRURE
7390	16	92mm
7391	22	92mm
7392	24	92mm
7880	16	85mm
7881	22	85mm
7882	24	85mm





# FECHADURAS ALAVANCA

## FECHADURA DE ALAVANCA 3 PONTOS

CERRADURA DE PALANCA 3 PUNTOS  
3 POINTS HANDLE ACTION LOCK  
SERRURES RELEVAGE 3 POINTS

### ROLETOS/ROLETOS/ROLLER/ ROULEAUX

REFS.	TESTA FRENTE FRONT GÂCHE	FECHADURA CERRADURA LOCK SERRURE
7490	16	92mm
7491	22	92mm
7492	24	92mm
7980	16	85mm
7981	22	85mm
7982	24	85mm

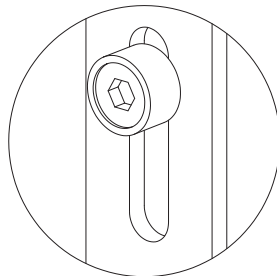

### COGUMELOS/BULONES/MUSHROOMS/ CHAMPIGNONS

REFS.	TESTA FRENTE FRONT GÂCHE	FECHADURA CERRADURA LOCK SERRURE
7590	16	92mm
7591	22	92mm
7592	24	92mm
7080	16	85mm
7081	22	85mm
7082	24	85mm

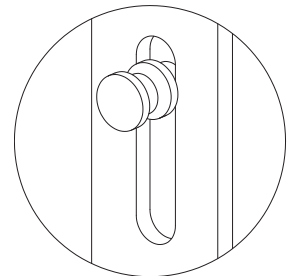

## FECHADURAS ALAVANCA

# FECHADURA DE ALAVANCA 3 PONTOS

CERRADURA DE PALANCA 3 PUNTOS  
3 POINTS HANDLE ACTION LOCK  
SERRURES RELEVAGE 3 POINTS

### GANCHO/PALANCA/LEVER/RELEVAGE

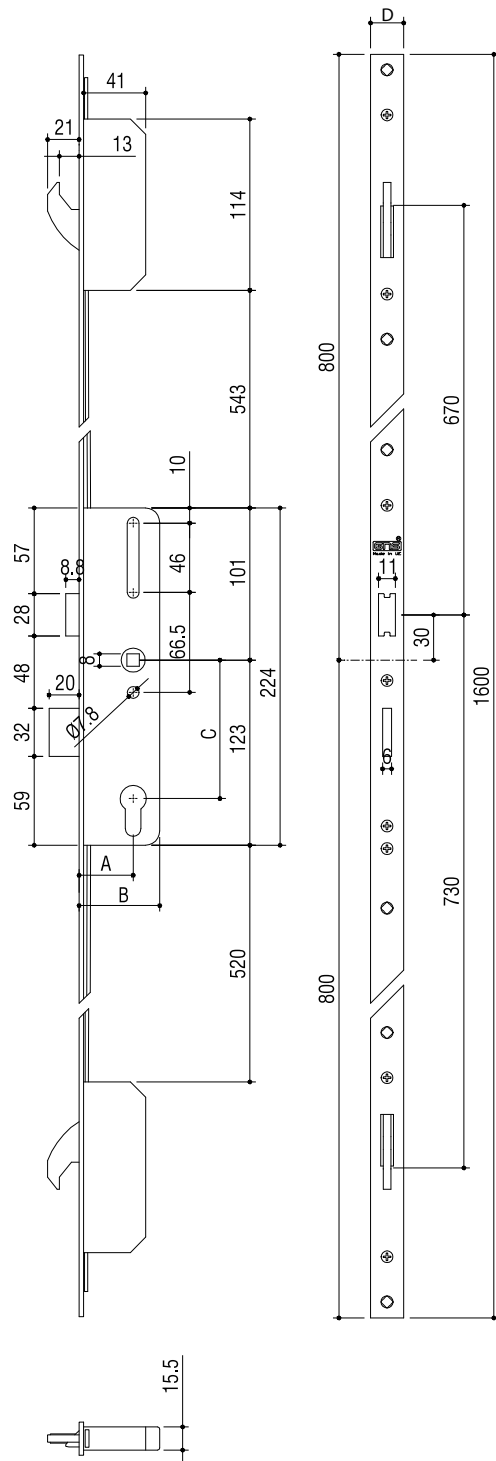

### GANCHO+ROLETOS/PALANCA+ROLETOS/ LEVER+ROLLER/RELEVAGE+ ROULEAUX

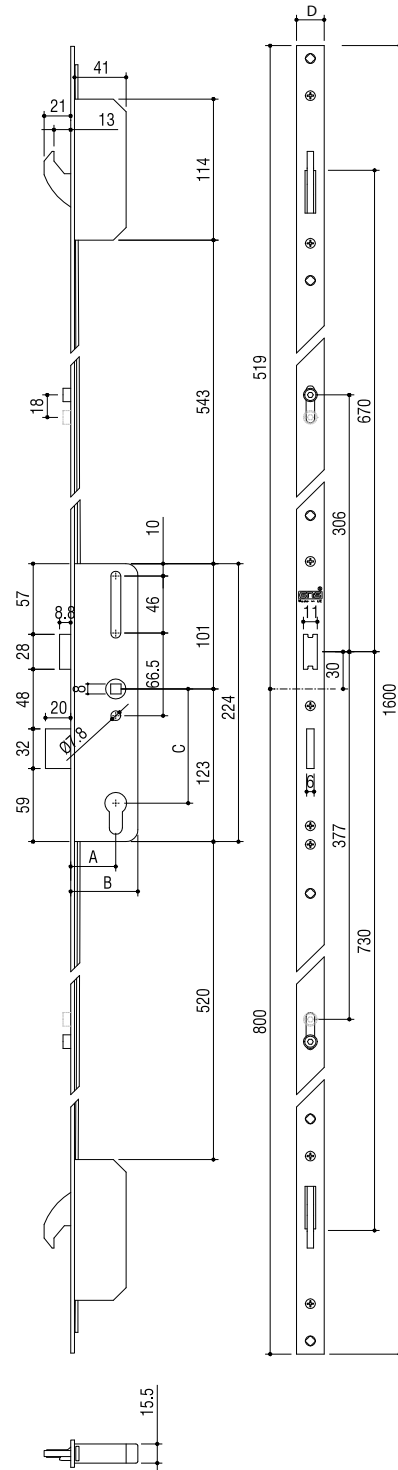

A	B	C	D
35mm	53 mm	85/92 mm	16 / 22 / 24 mm
45mm	63 mm	85/92 mm	16 / 22 / 24 mm



## FECHADURAS ALAVANCA

# FECHADURA DE ALAVANCA 1 PONTO

CERRADURA DE PALANCA 1 PUNTO

1 POINT HANDLE ACTION LOCK

SERRURE RELEVAGE 1 POINT

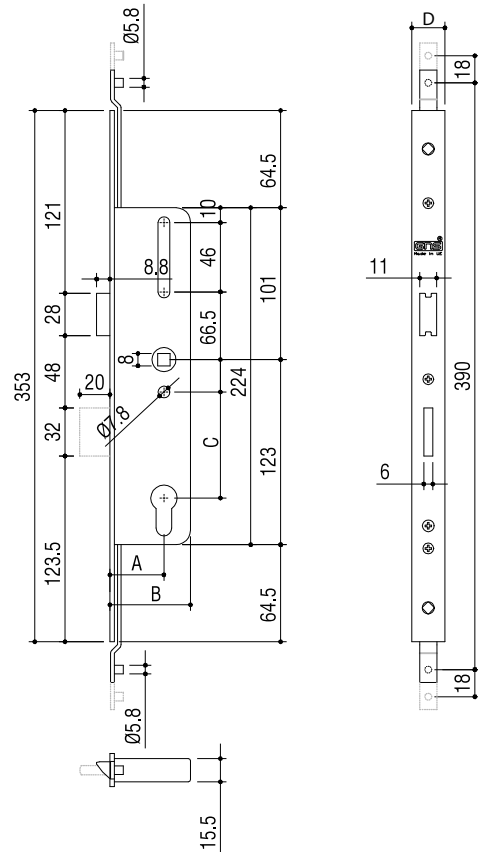

REFS.

TESTA  
FRENTE  
FRONT  
GÂCHE

FECHADURA  
CERRADURA  
LOCK  
SERRURE

7297  
7298  
7299

16  
22  
24

92mm  
92mm  
92mm

7776  
7777  
7778

16  
22  
24

85mm  
85mm  
85mm



INX

35

45

85

92

16

22

24



A	B	C	D
35mm	53 mm	85/92 mm	16 / 22 / 24 mm
45mm	63 mm	85/92 mm	16 / 22 / 24 mm

# FECHADURAS ALAVANCA

## FECHADURA DE ALAVANCA MULTIPONTO

CERRADURA DE PALANCA MULTIPUNTO  
MULTIPOINT HANDLE ACTION LOCK  
SERRURES RELEVAGE MULTIPOINT

7777K

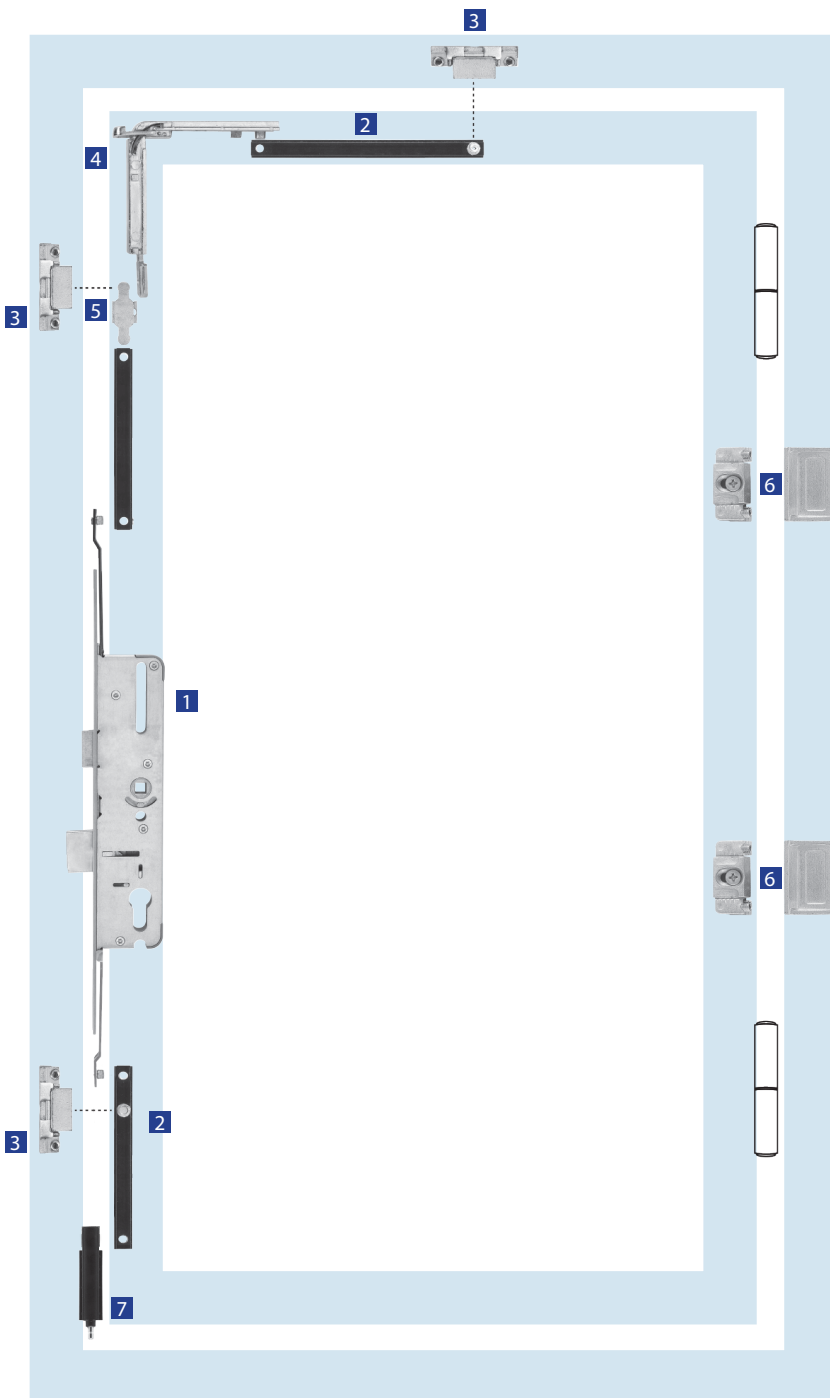

- |                              |                            |                              |                                 |
|------------------------------|----------------------------|------------------------------|---------------------------------|
| 1 Fechadura                  | 1 Cerradura                | 1 Mono point lock            | 1 Serrure                       |
| 2 Barra nylon ou alumínio    | 2 Barra nylon o alumínio   | 2 Nylon/alu transmission bar | 2 Nylon ou aluminium tige       |
| 3 Ponto de fecho OBT025      | 3 Punto de cierre OBT025   | 3 Locking point OBT025       | 3 Point de fermeture OBT025     |
| 4 Esquadro de reenvio        | 4 Escuadra de reenvio      | 4 Transmission corner        | 4 Angle de joue inférieure      |
| 5 Ligador OBT023             | 5 Pieza de encajar OBT023  | 5 Connector OBT023           | 5 Connecteur OBT023             |
| 6 Dobradiça oculta ref. 5215 | 6 Bisagra oculta ref. 5215 | 6 Hidden hinge ref. 5215     | 6 Charnière invisible ref. 5215 |
| 7 Ponteira nylon             | 7 Puntera nylon            | 7 Metal/nylon side lock      | 7 Orteil en nylon               |



# FECHADURAS ALAVANCA FECHADURA DE ALAVANCA

CERRADURA DE PALANCA 3 POINTS  
HANDLE ACTION LOCK  
SERRURES RELEVAGE

## INSTRUÇÕES - INSTRUCCIONES - INSTRUCTIONS - INSTRUCTIONS

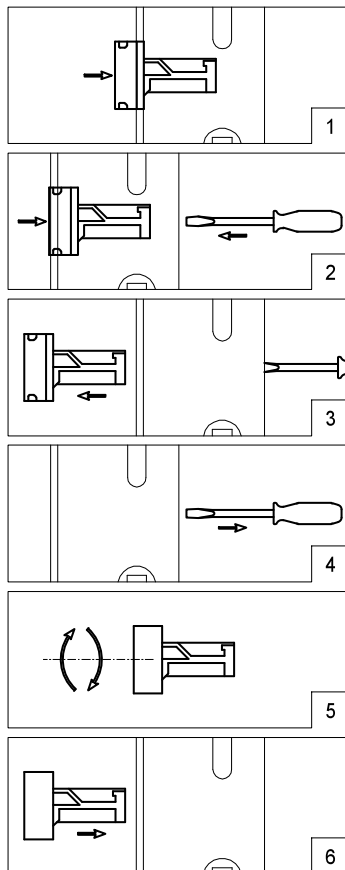
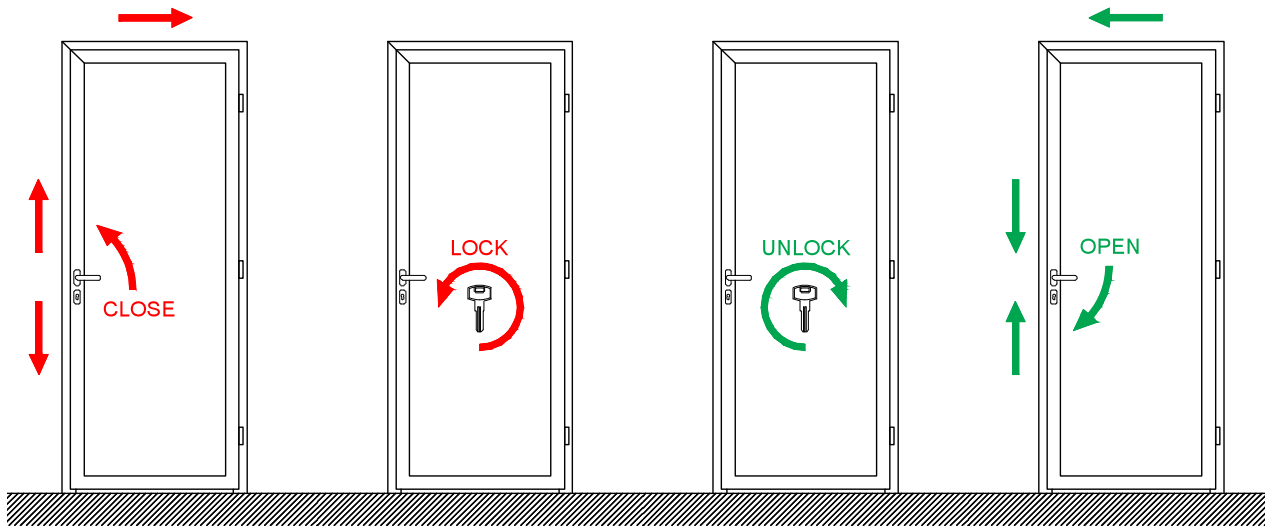

Virar Trinco  
Girar Picaporte Palanca  
Turn Handle ActionLatch  
Tourner le Demi-tour Relevage





**GNS - Georgina Neto dos Santos, Lda**

E.N.1 - Mourisca do Vouga  
Águeda - Portugal

P.O. Box 3007  
3754-901 Águeda, Portugal

**Geral**  
Telf. +351 234 644 224 / 44 Fax. +351 234 644 842

**Dep. Comercial**  
Telf. +351 234 645 099

[www.ingns.com](http://www.ingns.com)  
[gns@gns.mail.pt](mailto:gns@gns.mail.pt)



**ANCOSI, Lda**

E.N.1 - Mourisca do Vouga  
Águeda - Portugal

P.O. Box 3007  
3754-901 Águeda, Portugal

**Geral**  
Telf. +351 234 645 319 / 44 Fax. +351 234 645 922

[www.ancosi.com](http://www.ancosi.com)  
[ancosi@ancosi.com](mailto:ancosi@ancosi.com)

